

JOY

— By ITEMDesign Works —
Javier Cuñado



■ **DESCRIPTION**

- ① **Polypropylene (P.P) frame**, 5 mm thick, with glass fibre.
- ② Model with or without arms. Model with arms: **polypropylene (P.P) armrests** in the same colour as the frame.
- ③ **Optional seat**: Upholstered with an ergonomic cushion (110-120 kg/m³) in upholstered in fabric Group: T and M or (TPU) - (PUR) Poliurethane
- ④ **Bottom structure**: 24,5 x 12 mm ovale steel tube bars, 1.5 mm thick. Lower polypropylene frame covering the structure.
- ⑤ **Structure** made with cylindrical hot-rolled steel tubes, Ø13mm and e=2 mm, with a 90-micron thick epoxy paint coating.
- ⑥ **End caps** in a graphite grey finish.



■ **SHELL**



5 mm polypropylene (P.P) with 30% fibreglass in a wide range of colours.

■ **UPHOLSTERED SEAT**

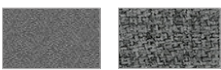

Upholstered foam seat (40kg/m³) in groups T and M.

■ **PU SEAT**



■ **DIMENSIONS**

- Total Height: 813 mm
- Total Width: 517 mm
- Total Depth: 540 mm
- Seat Height: 455 mm or 474 mm with cushioned seat
- Seat Width: 440 mm
- Seat Depth: 400 mm

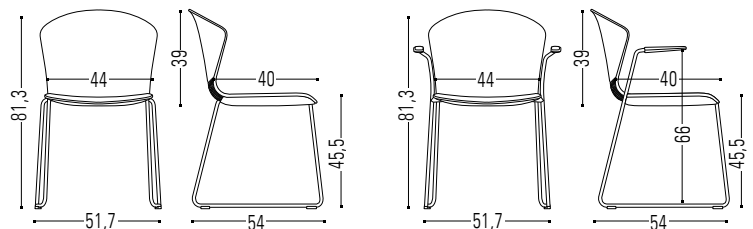

■ **STRUCTURE FINISH**



Ø13x2 mm hot-rolled steel tube in a white, black, aluminised or chrome finish.

■ **OPTIONAL ACCESSORIES**



For **projects of facilities** that require **concatenated joints of the chairs and minimum quantities of 100 units**, consult with **Sales Department**. *Can only be used on armless Cantilever chairs.*

■ **STACKING**

The Joy cantilever is designed for the seats to be stacked on top of one another, with the ability to stack **up to 30 chairs in the stacking cart and up to 15 chairs in the standard way**. (the armless model without an upholstered seat)



■ **DESCRIPTION**

- ① **Polypropylene (P.P) frame**, 5 mm thick, with glass fibre.
- ② Model with or without arms. Model with arms: **polypropylene (P.P) armrests** in the same colour as the frame.
- ③ **Optional seat**: Upholstered with an ergonomic cushion (110-120 kg/m³) in upholstered in fabric Group: T and M or (TPU) - (PUR) Poliurethane
- ④ **Bottom structure**: 24,5 x 12 mm ovale steel tube bars, 1.5 mm thick. Lower polypropylene frame covering the structure.
- ⑤ **Structure** made with cylindrical hot-rolled steel tubes, Ø16mm and e=2 mm, with a 90-micron thick epoxy paint coating.
- ⑥ **End caps** in a graphite grey finish.



■ **SHELL**



5 mm polypropylene (P.P) with 30% fibreglass in a wide range of colours.

■ **UPHOLSTERED SEAT**

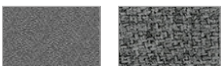

Upholstered foam seat (40kg/m³) in groups T and M.

■ **PU SEAT**



■ **DIMENSIONS**

- Total Height: 813 mm
- Total Width: 517 mm
- Total Depth: 540 mm
- Seat Height: 455 mm or 474 mm with cushioned seat
- Seat Width: 440 mm
- Seat Depth: 400 mm

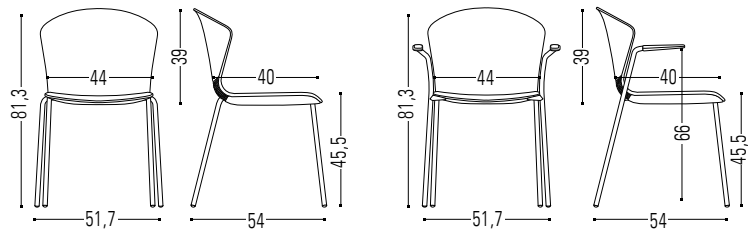

■ **STRUCTURE FINISH**



Ø13x2 mm hot-rolled steel tube in a white, black, aluminised or chrome finish.

■ **STACKING**

The 4 legs chairs is designed for the seats to be stacked on top of one another, with the ability to stack **up to 30 chairs in the stacking cart** and **up to 15 chairs in the standard way**. (armless model without an upholstered seat)



STACKABILITY

JOY chair is designed to offer a very high stacking level on both models: 4 legs and cantilever frame.

JOY cantilever frame provides the possibility of stacking up to **30 chairs on the trolley** and up to **15 chairs vertically positioned**. (only without seat pad).

On the other hand, the 4 legs model provides the possibility of stacking up to **30 chairs on the trolley** and up to **15 chairs vertically positioned**. (only without seat pad).



NOTE: We suggest that chrome frames are used on projects where intensive use is required and where stacking/unstacking of chairs is done very often. Nevertheless, you can check with Sales department a special option to have both 4 legs and cantilever frames painted in high-resistant two-coated white paint based on quantities only for projects.

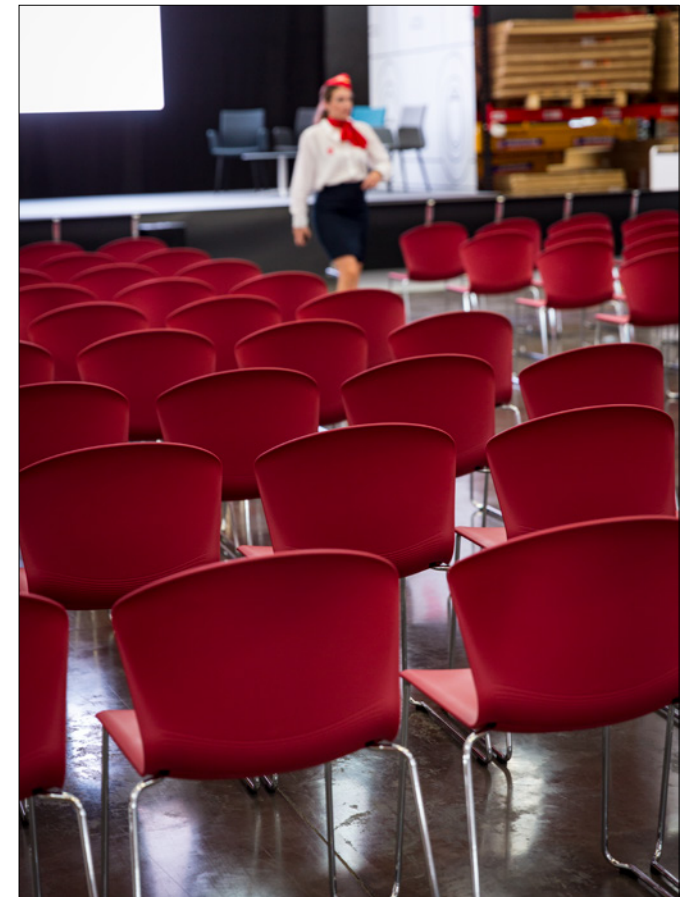

Stacking Details

		Trolley stacking capacity	Vertical stacking capacity
		Quantity of chairs	Quantity of chairs
4 legs model	With bottom cover	30	15
	Without bottom cover	35	15
Cantilever frame	With bottom cover	30	15
	Without bottom cover	40	20

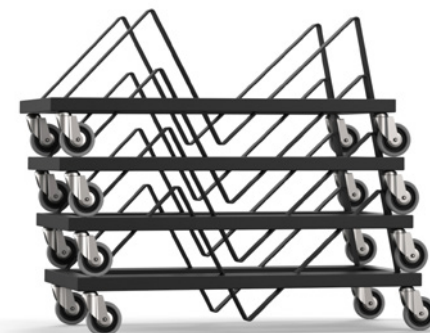

The trolley can also be stacked when empty for space-saving

NOTE: Chairs can also be ordered without the under-seat carcass only for Projects and based on quantities to improve the stacking capacity. Please check with Sales department.

■ **DESCRIPTION**

- ① **Polypropylene (P.P) frame**, 5 mm thick, with glass fibre.
 - ② **Model without arms.**
 - ③ **Optional seat:** Upholstered with an ergonomic cushion (110-120 kg/m³) in upholstered in fabric Group: T and M or (TPU) - (PUR) Poliurethane
 - ④ **Bottom structure:** 24,5 x 12 mm ovale steel tube bars, 1.5 mm thick.
 - ⑤ Lower polypropylene frame covering the structure.
 - ⑥ **Structure** made with cylindrical hot-rolled steel tubes, Ø13mm and e=2 mm, with a 90-micron thick epoxy paint coating.
 - ⑦ Ø13x2 mm hot-rolled steel cylindrical tube **footrest**. Protector for placing feet on chairs with a painted structure.
- End caps** in a graphite grey finish.

■ **SHELL**



5 mm polypropylene (P.P) with 30% fibreglass in a wide range of colours.

■ **UPHOLSTERED SEAT**

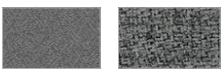

Upholstered foam seat (40kg/m³) in groups T and M.

■ **PU SEAT**



■ **STRUCTURE FINISH**



Ø13x2 mm hot-rolled steel tube in a white, black, aluminised or chrome finish.

■ **DIMENSIONS**

- Total Height: 1120 mm
- Total Width: 517 mm
- Total Depth: 540 mm
- Seat Height: 760 mm or 779 mm with cushioned seat
- Seat Width: 440 mm
- Seat Depth: 400 mm

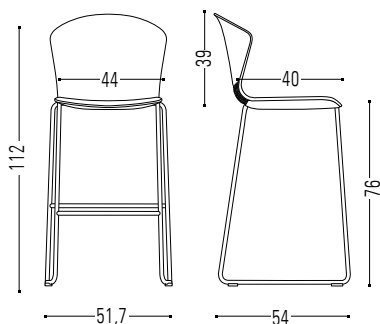

- **Not Stackable**



■ **DESCRIPTION**

- ① **Polypropylene (P.P) frame**, 5 mm thick, with glass fibre.
- ② Model without arms.
- ③ **Optional seat:** Upholstered with an ergonomic cushion (110-120 kg/m³) in upholstered in fabric Group: T and M or (TPU) - (PUR) Poliurethane
- ④ **Bottom structure:** Bottom structure: Bottom frame of injected aluminum, which gives the chair greater precision, lightness and recyclability, covering the structure
- ⑤ **Wooden legs** with a conical shape in a natural beech wood or black lacquered finish.
- ⑥ Polypropylene (P.P) **End caps** in black with non-slip felt



■ **SHELL**



5 mm polypropylene (P.P) with 30% fibreglass in a wide range of colours.

■ **UPHOLSTERED SEAT**

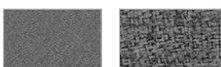

Upholstered foam seat (40kg/m³) in groups T and M.

■ **PU SEAT**



■ **LEGS FINISH**



Wooden legs with a conical shape in a beech wood finish.

■ **DIMENSIONS**

- Total Height: 800 mm
- Total Width: 440 mm
- Total Depth: 480 mm
- Seat Height: 455 mm or 474 mm with cushioned seat
- Seat Width: 440 mm
- Seat Depth: 400 mm

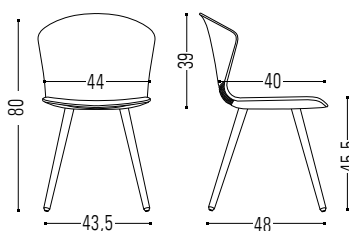

■ **DESCRIPTION**

- ① **Polypropylene (P.P) frame**, 5 mm thick, with glass fibre.
- ② Model without arms.
- ③ **Optional seat:** Upholstered with an ergonomic cushion (110-120 kg/m³) in upholstered in fabric Group: T and M or (TPU) - (PUR) Poliurethane
- ④ **Bottom structure:** Bottom structure: Bottom frame of injected aluminum, which gives the chair greater precision, lightness and recyclability, covering the structure
- ⑤ **Wooden legs** with a conical shape in a natural beech wood or black lacquered finish.
- ⑥ Ø13x2 mm hot-rolled steel cylindrical tube **footrest**. Black Finish
- ⑦ Polypropylene (P.P) **End caps** in black with non-slip felt

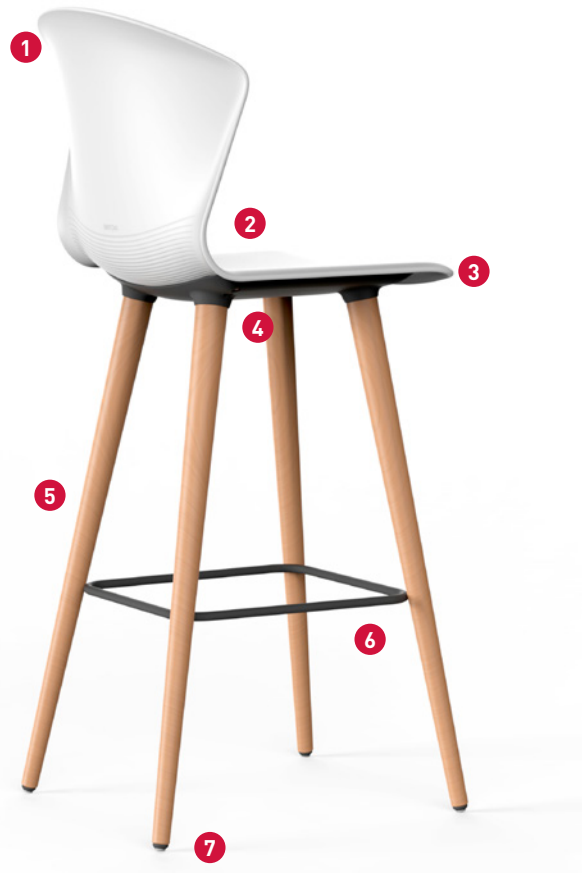

■ **SHELL**



5 mm polypropylene (P.P) with 30% fibreglass in a wide range of colours.

■ **UPHOLSTERED SEAT**

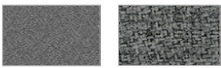

Upholstered foam seat (40kg/m³) in groups T and M.

■ **PU SEAT**



■ **LEGS FINISH**



Wooden legs with a conical shape in a beech wood finish.

■ **DIMENSIONS**

- Total Height: 1120 mm
- Total Width: 517 mm
- Total Depth: 540 mm
- Seat Height: 760 mm or 779 mm with cushioned seat
- Seat Width: 440 mm
- Seat Depth: 400 mm

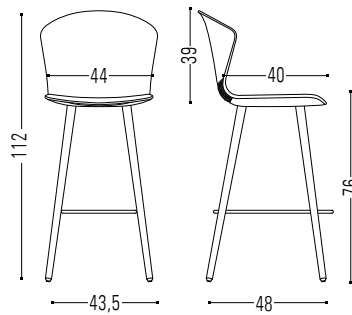

■ **DESCRIPTION**

- ① **Polypropylene (P.P) frame**, 5 mm thick, with glass fibre.
- ② Model without arms.
- ③ **Optional seat:** Upholstered with an ergonomic cushion (110-120 kg/m³) in upholstered in fabric Group: T and M or (TPU) - (PUR) Poliurethane
- ④ **Bottom structure:** Bottom structure: Bottom frame of injected aluminum, which gives the chair greater precision, lightness and recyclability, covering the structure .
- ⑤ **Gas lift**
- ⑥ 5-spoke rotating **base** made of injected aluminium or polyamide with fibreglass.
- ⑦ Standard silent **castors** Optional hole, antistatic or auto-brake castors.



■ **SHELL**



5 mm polypropylene (P.P) with 30% fibreglass in a wide range of colours.

■ **UPHOLSTERED SEAT**

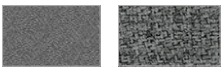

Upholstered foam seat (40kg/m³) in groups T and M.

■ **PU SEAT**



■ **BASE**



Polyamide Base - Ø67.5 cm



Black



Aluminium injection base - Ø67.5 cm



White Silver

■ **CASTORS AND CAPS**

Standard Castors



Standard

Auto-breaking castors



Optional

Auto-breaking Hole castors



Anti-static castors



Polypropylene caps



■ **DIMENSIONS**

- Total Height: 870 -970 mm
- Total Width: 675 mm
- Total Depth: 675 mm
- Seat Height: 420-530 mm or 439-549 mm with cushioned seat
- Seat Width: 440 mm
- Seat Depth: 400 mm

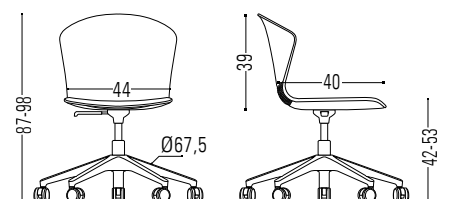

■ **DESCRIPTION**

- ① **Polypropylene (P.P) frame**, 5 mm thick, with glass fibre.
- ② Model without arms.
- ③ **Optional seat:** Upholstered with an ergonomic cushion (110-120 kg/m³) in upholstered in fabric Group: T and M or (TPU) - (PUR) Poliurethane
- ④ **Bottom structure:** Bottom structure: Bottom frame of injected aluminum, which gives the chair greater precision, lightness and recyclability, covering the structure
- ⑤ **Gas lift**
- ⑥ Ø18 x 1.5mm chrome steel **footrest** ring, 1.5 mm thick.
- ⑦ 5-spoke rotating **base** 5-spoke rotating made of injected aluminium or polyamide with fibreglass.
- ⑧ Standard silent **castors** Optional hole, antistatic or auto-brake castors.



■ **SHELL**



5 mm polypropylene (P.P) with 30% fibreglass in a wide range of colours.

■ **UPHOLSTERED SEAT**

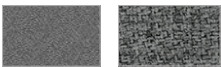

Upholstered foam seat (40kg/m³) in groups T and M.

■ **PU SEAT**



■ **BASE**



Polyamide Base - Ø67.5 cm



Black



Aluminium injection base - Ø67.5 cm



White



Silver

■ **CASTORS AND CAPS**

Standard Castors



Standard

Auto-breaking castors



Optional

Auto-breaking Hole castors



Anti-static castors



Polypropylene caps



■ **DIMENSIONS**

- Total Height: 1065-1225 mm
- Total Width: 675 mm
- Total Depth: 675 mm
- Seat Height: 685-845 mm or 704-864 mm with cushioned seat
- Seat Width: 440 mm
- Seat Depth: 400 mm

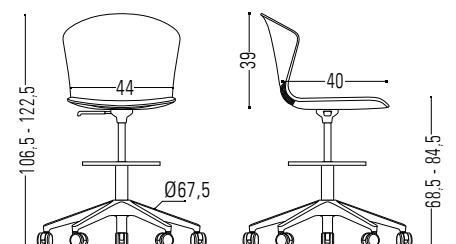

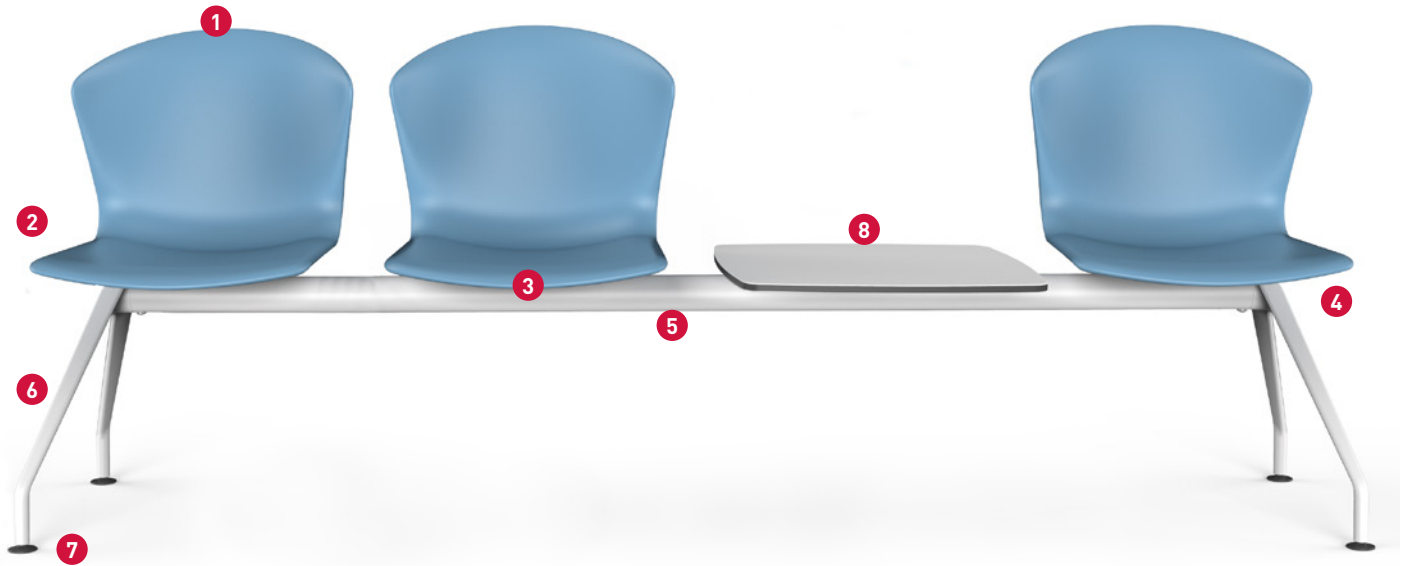

■ **DESCRIPTION**

- ① Polypropylene (P.P) frame, 5 mm thick, with glass fibre .
- ② Model without arms.
- ③ **Optional seat:** Upholstered with an ergonomic cushion (110-120 kg/m3) in upholstered in fabric Group: T and M or (TPU) - (PUR) Poliurethane
- ④ **Bottom structure:** Bottom structure: Bottom frame of injected aluminum, which gives the chair greater precision, lightness and recyclability,covering the structure
- ⑤ **Lower steel tube structural beam,** 60 x 3 mm-thick circular section
- ⑥ **Injected aluminium legs** with a 90-micron thick epoxy paint coating
- ⑦ 3 mm thick polypropylene (P.P) **end caps** in a black finish.
- ⑧ **Optional C. Laminate table** in white or black finish - 13 mm thick

■ **SHELL**



5 mm polypropylene (P.P) with 30% fibreglass in a wide range of colours.

■ **UPHOLSTERED SEAT**

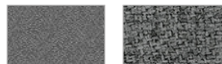

Upholstered foam seat (40kg/m³) in groups T and M.

■ **PU SEAT**



■ **STRUCTURE FINISH**



Aluminium injection legs



■ **DIMENSIONS**

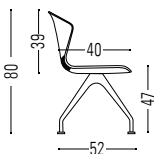

- Total Height: 800 mm
- Total Width: según modelos
- Total Depth: 520 mm
- Seat Height: 455 mm or 474 mm with cushioned seat
- Seat Width: 440 mm
- Seat Depth: 400 mm

Model 3 posts

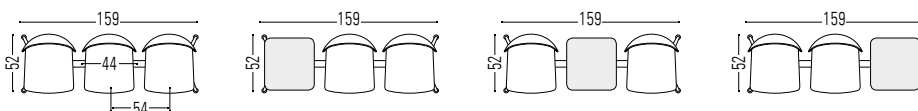

Model 4 posts

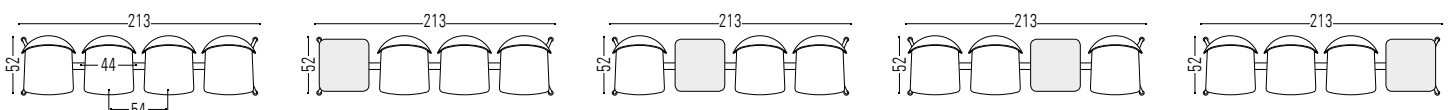

Model with seats



Model 3 posts

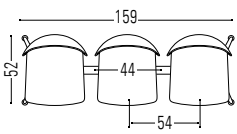

Model 4 posts

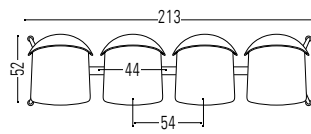

Model with seats with auxiliary table



Model 3 posts

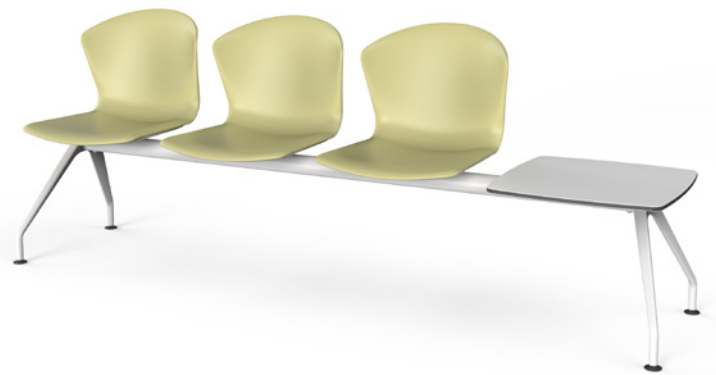
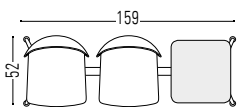
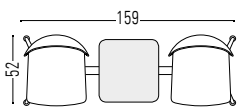
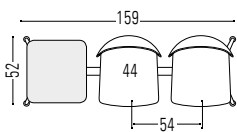

Model 4 posts

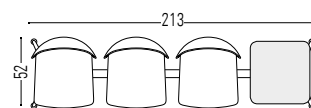
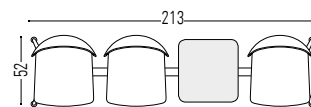
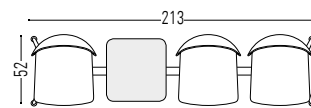
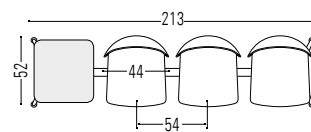

■ Available combinations for the following models:



Cantilever



4 legs



Cantilever stool



White Frame

- Black arms
- White lower cover
- Structure - Any finish



Black Frame

- Black arms
- Black lower cover
- Structure - Any finish



Blue/Grey/Red/Lime Frame

- Black arms
- White lower cover
- Structure - White finish



Blue/Grey/Red/Lime Frame

- Black arms
- Black lower cover
- Structure - Black, Silver or Chrome finish

■ Available combinations for the following models:



4 wood legs



Wood legs stool



Gas lift



Draughtsman chair



Bench seating



Frame: Any finish

- Black lower cover
- Structure / Base - Any finish



MATERIALS

Maximum use of materials to eliminate and minimize scraps. Use of recyclable and recycled materials in those components that do not affect the functionality and durability.

HIGH
RECYCLABLE
MATERIALS



PRODUCTION

Maximum optimization of energy use. Minimal environmental impact. Last generation technological systems. Zero discharge of wastewater. No VOC coatings. Processes free of heavy metals, phosphates, OC and COD.

100%
RECYCLABLE
ALUMINIUM, STEEL
& WOOD



TRANSPORT

Detachable systems. Volumes that facilitate the optimization of space. Maximum reduction of energy consumption by transport.

100%
RECYCLABLE
PACKAGE AND THINNER
FREE



USE

Quality and warranty. Long lasting. Replacements available.

EASY
TO CLEAN
AND MAINTAIN



DISPOSAL

Waste reduction. Supplier-manufacturer packaging reuse system. Components are easy to be separated. Inks in packaging are water-based, without solvents.

HIGH
RECYCLABLE
MATERIALS

■ **CERTIFICATES AND REFERENCES**

The different programmes get points in different environmental categories to get the LEED certificate (sustainability, material and resources, water, energy and atmosphere, inner environment quality, innovation and design).

 The mark of responsible forestry	 PEFC Certificate	 EN ISO 14006:2011 ECODESIGN Certificate	 UNE-EN ISO 9001:2008 ISO 9001 Certificate	 UNE-EN ISO 14001:2004 ISO 14001 Certificate	 E1 Certificate by EN 13986	 ACTIU TECHNOLOGY PARK LEED® PLATINUM certified by USGBC Leadership in Energy & Environmental Design <small>LEED® Gold certified 2011 - LEED® Platinum certified 2017</small>
---	---	---	---	--	--	--