

Other documents available for this product

Technical information for SILENT ROOM M, L, XL

Ordering guidelines for SILENT ROOM

User manual for SILENT ROOM

Troubleshooting manual for SILENT ROOM

Technical guide for SILENT ROOM

Quality standard

ISO 23351-1:2020

Warranty

See Warranty statement

Ceiling

External walls

Internal front central wall

Control box

Floor



Internal acoustic walls

Internal front walls

Table

Door

Technical information

External Walls

Options

- Upholstered with fabric (1)
- Melamine (2)
- Upholstered with fabric. Rear wall with glass (3)
- Melamine. Rear wall with glass (4)

5 panels upholstered with fabric

- Welded frame is made of metal tube 40x20 mm;
- Angular brackets are made of 40x40 mm metal tubes;
- Powder coated metal;
- Plastic feet with height levelling (+30 mm);
- 12 mm MFC (melamine);
- Covered with 3 mm foam;
- Upholstered with fabric.

1 solid panel from melamine

- Welded frame is made of metal tube 40x20 mm;
- Angular brackets are made of 40x40 mm metal tubes;
- Powder coated metal;
- Plastic feet with height levelling (+30 mm);
- 16 mm MFC (melamine) with 1 mm ABS edging.

Walls with glass panes

- Welded frame is made of metal tube 40x20 mm;
- Powder coated metal;
- Inside gasket is made of 12 mm MFC (melamine) with 1 mm ABS edging;
- Front sides and top of the metal frame are covered with 16 mm MFC (melamine) with 1 mm ABS edging;
- 8 mm TSG (tempered safety glass), clear.

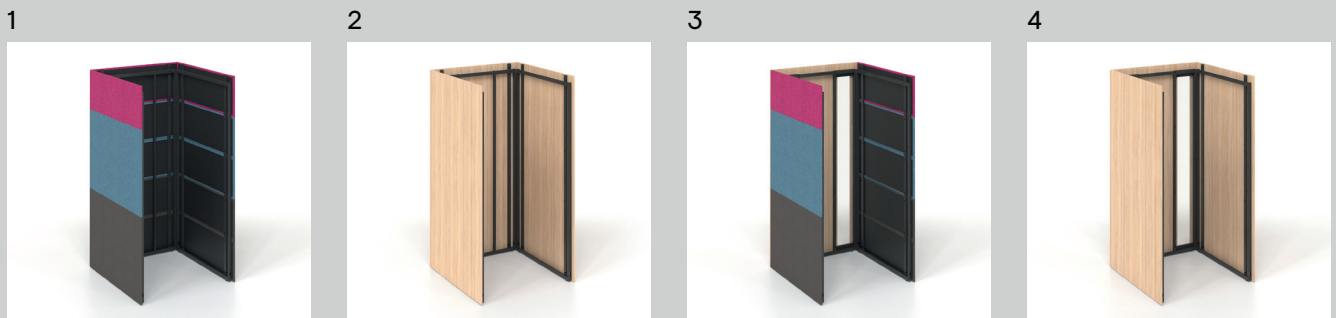

Internal acoustic walls (1)

Panels upholstered with fabric

- Frame is made of 40x20 mm metal tube;
- Powder coated metal;
- 12 mm MFC (melamine);
- 40 mm of acoustic foam;
- Upholstered with fabric.

Internal front walls

Options

- Upholstered with fabric (2)
- Melamine panel (3)
- If you order external walls with glass panes, you do not need to choose internal front walls

Melamine panel

- Frame is made of 40x20 mm metal tube;
- Powder coated metal;
- 16 mm MFC (melamine) with 1 mm ABS edging.

Panels upholstered with fabric

- Frame is made of 40x20 mm metal tube;
- Powder coated metal;
- 12 mm MFC (melamine);
- Covered with 3 mm foam;
- Upholstered with fabric.

1

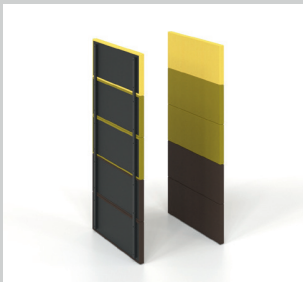

2

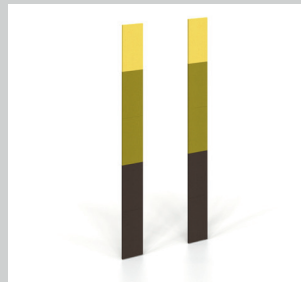

3



Internal front central wall

Wall with control unit (1)

- Top front panel is made of 16 mm MFC (melamine) with 1 mm ABS edging;
- Bottom front panel with hinges is made of 16 mm MFC with 1 mm ABS edging;
- Sides and internal construction parts made of 16 mm MFC with 0,5 mm ABS edging;
- Ventilation and lighting dimming knobs are made of PA 2200 (Nylon);

Control box (3)

- Input (GST18i3 male): 100-240 V;
- Output (GST18i3 female): 100-240 V;
- Frequency: 50/60 Hz;
- Power cable: EU, UK, FR, CH, US – GST18i3 female, 3 m;
- Power output cable length: 0,5 m - GST18i3 male - GST18i3 female;
- Power consumption – max. 229W, standby 4,5W.

Table (2)

- Tabletop is made of 16 mm MFC (melamine) with 1 mm ABS edging;
- Box for wires (135x150x100 mm) underneath the table top is made of 1 mm powder coated metal sheet;
- Bracket made of 40x20 mm metal tube;
- Powder coated metal;
- Mounted 1 AC power socket (100-240 V) with or without integrated USB fast charger (USB Type A+C, max 5A);
- Load capacity – 25 kg.

1



2



3



Ceiling (1)

Composition

- Double layered ceilings are made of 12 mm top and 16 mm bottom MFC (melamine) panels with 1 mm ABS edging;
- Frame is made of 50x20 mm metal tube;
- PIR sensor mounted in to central ceiling segment;
- Fan grills are made of 1 mm metal sheet;
- Powder coated metal;
- Air supply duct inside glued with acoustic foam;
- Ø60 mm cable grommet for optional power supply from ceiling.

Lighting

- 3x LED modules (8,92W) colour temperature approx. 3000 K dimmable;
- 3x LED housing (asymmetrical) made of aluminium;
- Replacement for LED modules can only be purchased from the manufacturer.

Ventilation

- 2x air supply fans are located in the ceilings;
- 2x air exhaust slots are located in central segment of the ceilings for natural ventilation;
- Maximum airflow approx. 200 m³/h.

Doors (2)

- Left-handed or right-handed option;
- Metal door frame is made of 40x40 mm tube and 40x8 mm steel rod;
- Powder coated metal;
- Aluminium profiles with PVC sealing fixed to internal sides and top and bottom of door frame;
- Top of the metal frame is covered with 16 mm MFC (melamine) with 1 mm ABS edging;
- 8 mm TSG (tempered safety glass), clear;
- Clear width of a door opening - 1004 mm.

1

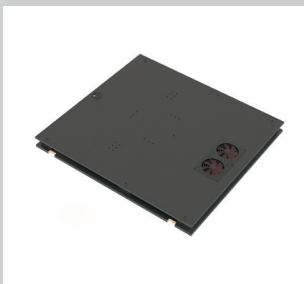

2



Floors (optional) (1)

- Metal floor frame is made of 40x40 mm and 40x20 mm tube;
- Powder coated metal;
- Floor panels are made of 25 mm MFC with 0,5 mm ABS edging;
- Floor carpet thickness 3 mm, made of PA6 (40%) and PP (60%);
- Skirting boards made of 16 mm MFC with 1 mm ABS edging;
- Plastic feet with height levelling (+30 mm).
- Note that the floor adds approximately 70 mm to the overall height.

Carpet (optional) (2)

- Carpet thickness 6,5 mm, made of 100% polyamide, antistatic;
- It is highly recommended to use the carpet when placing the SILENT ROOM on the hard flooring.
- If you are planning to place the SILENT ROOM on your carpet, you do not need to order the additional carpet.
- Uneven floor can be the cause of sound insulation problems.

1



2



Range

Fabric + fabric back version

Product weight: 305 kg

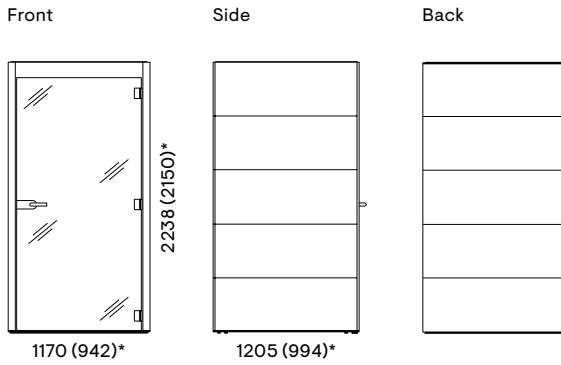

Total height with floor: 2306 mm

Melamine + melamine back version

Product weight: 315 kg

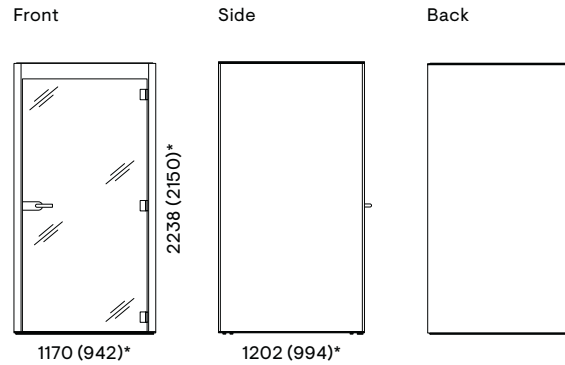

Total height with floor: 2306 mm

Fabric + glass back version

Product weight: 302 kg

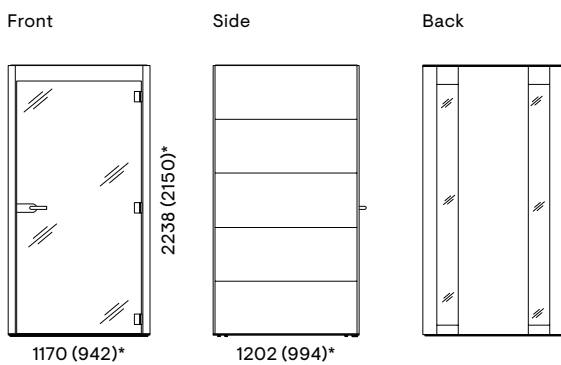

Total height with floor: 2306 mm

Melamine + glass back version

Product weight: 308 kg

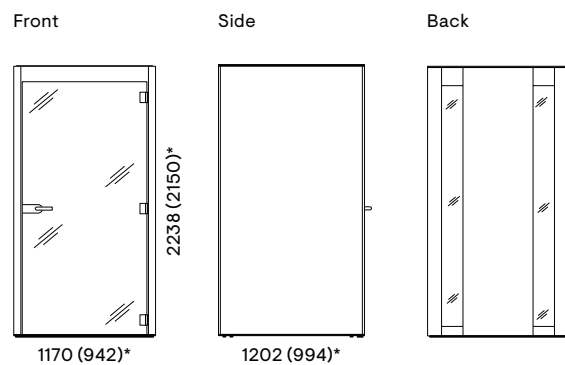

Total height with floor: 2306 mm

* External dimension (internal dimension)

!

Recommended height of the space for SILENT ROOM installation – ≥ 2400 mm (without floor).

Recommended height of the space for SILENT ROOM installation – ≥ 2470 mm (with floor).

Additional information

Shipping dimensions

WxDxH: 2250x1180x695 mm
(Accessories not included)

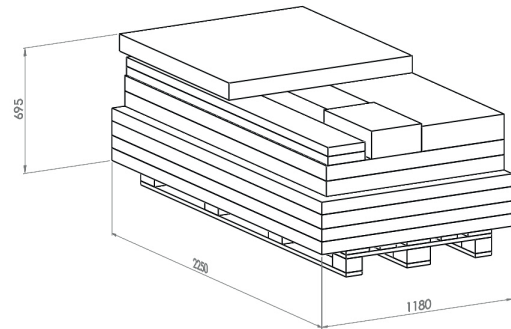

Automatic operation

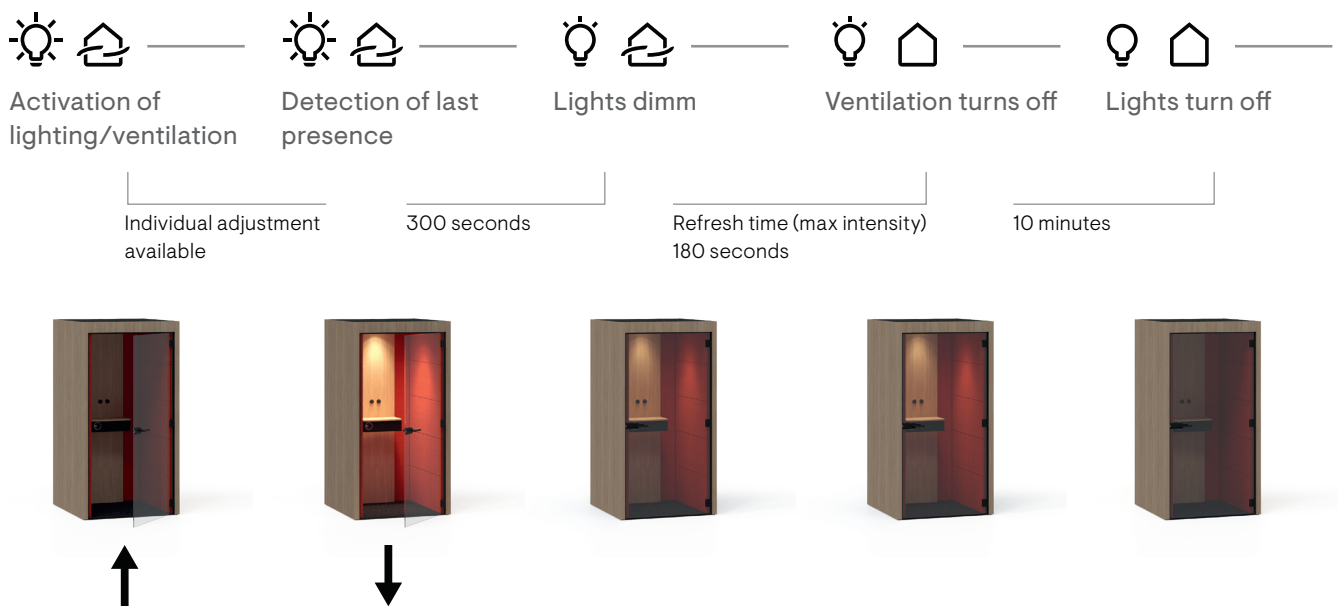

Information about available accessories for this range can be found in our product pricelists.