

/ nuvola



nuvo a

design
R&D Bralco



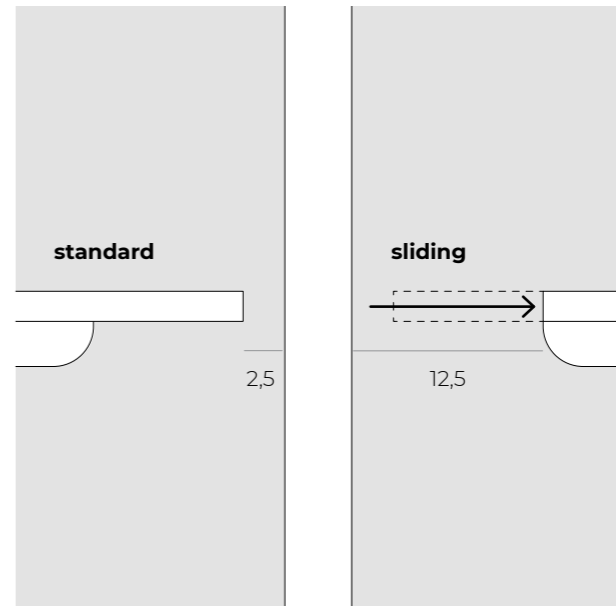
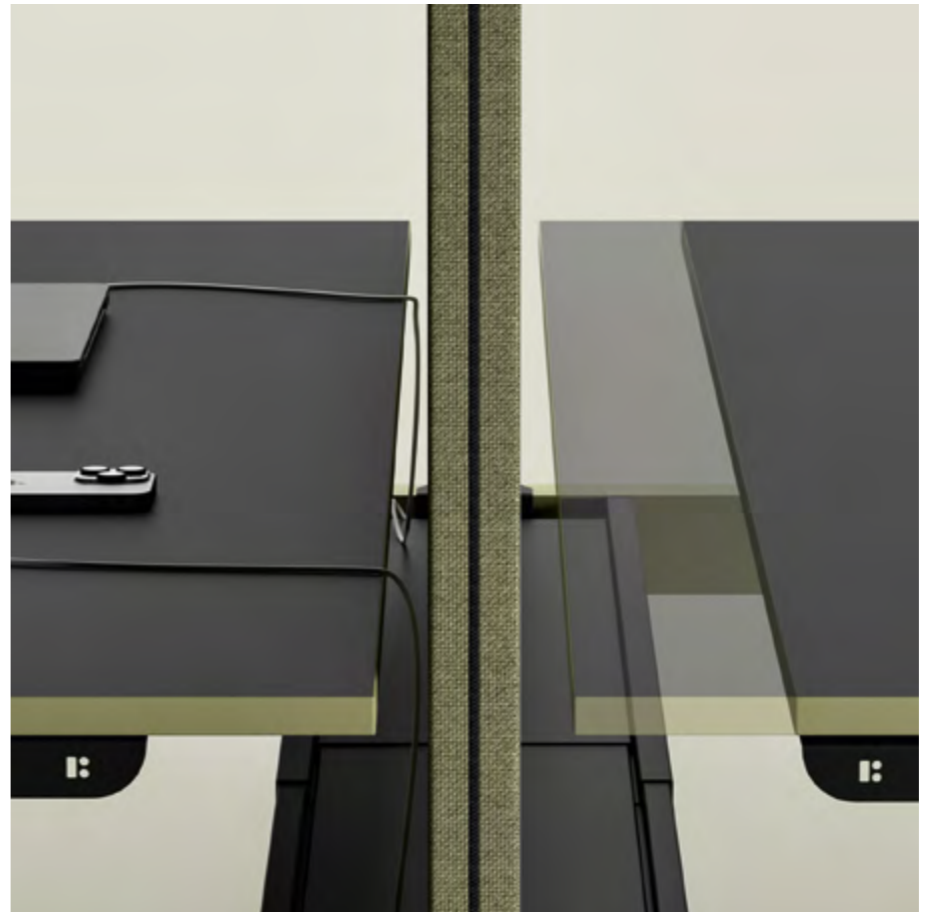















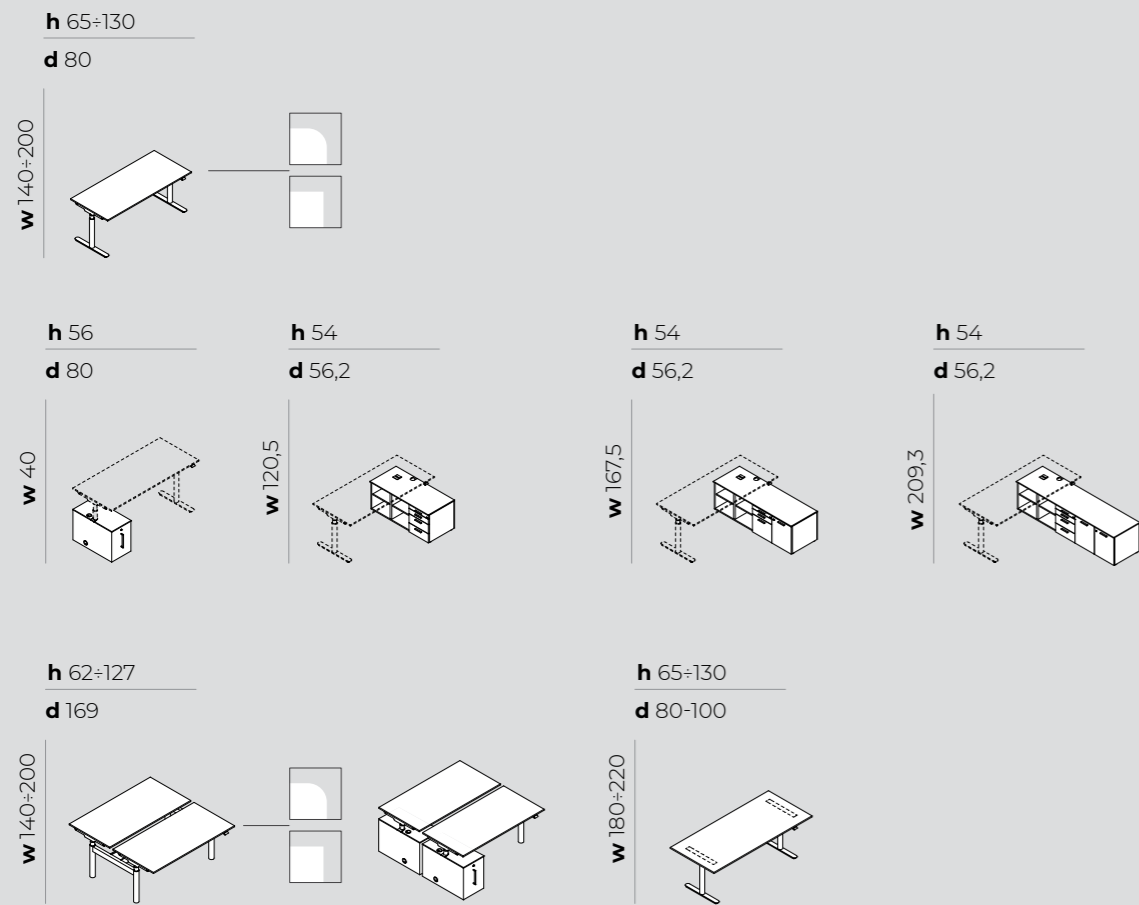

accessori • accessories • accessoires • Zubehör • accesorios



- gonna**
modesty panel
voile de fond
Knieraumblende
faldón
- schermo H 57,5**
screen H 57,5
écran H 57,5
Schirm H 57,5
pantalla H 57,5
- schermo H 86,5**
screen H 86,5
écran H 86,5
Schirm H 86,5
pantalla H 86,5
- schermo H 48 (x2)**
screen H 48 (x2)
écran H 48 (x2)
Schirm H 48 (x2)
pantalla H 48 (x2)



measure in cm • measurements in cm • mesures en cm • Maße in cm • medidas en cm

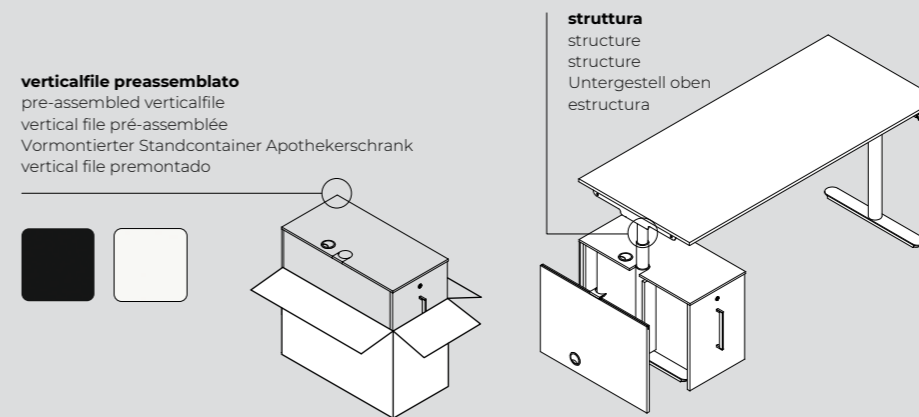

scrivanía • desk • bureau • Schreibtisch • escritorio

- struttura**
basic structure
structure
Untergestell oben
estructura
- metallo**, metal, métal, metal, metal
- rivestimento gamba e piede**
foot and leg covering
couvre-pieds et jambes
Fuß- und Beinbedeckung
cubre pies y piernas
- metallo**, metal, métal, metal, metal
- piano**
worktop
plateau
tischplatte
plano
- melaminico**, melamine, mélamine, melamin, melamina

mobili di servizio • service side units • éléments de service • Sideboard • módulos de servicio

- struttura**
structure
structure
Korpus
estructura
- ante-top**
doors-top
portes-top
Fronten-Abdeckplatte
puertas-tapa
- melaminico**, melamine, mélamine, melamin, melamina
- melaminico**, melamine, mélamine, melamin, melamina

elettrificazione • electrification · electrification · Elektrisierung · electrificación



scrivania • desk · bureau · Schreibtisch · escritorio

passaggio cavi integrato
integrated cable management
acheminement des câbles intégré
integrierte Kabelführung
enrutamiento de cables integrado

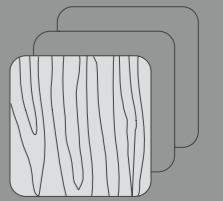
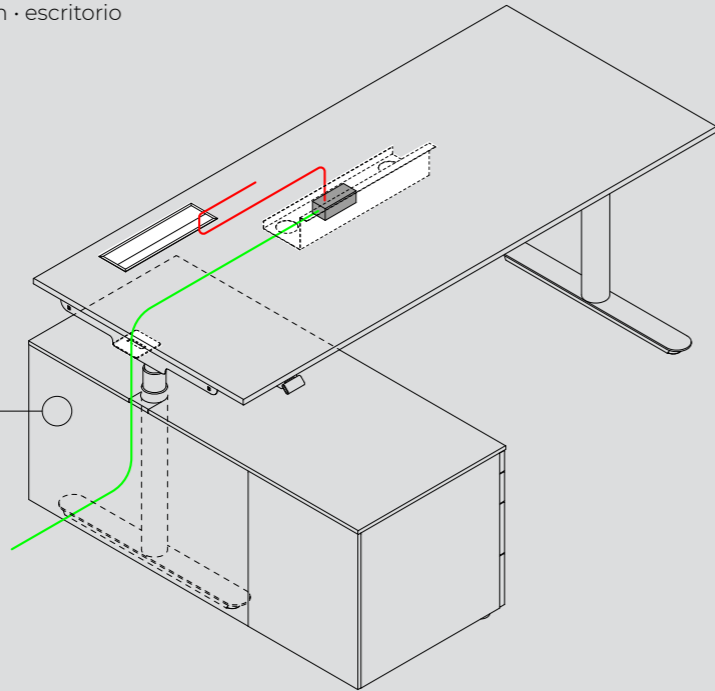

FINITURE E COLORI
finishing and colors
finitions et couleurs
Oberfläche und farben
acabados y colores

Bench

vasca-trave raccogli cavi con chiusura a scorrimento
cable collection beam with sliding top closure
poutre de collecte de câbles avec fermeture coulissante
Kabelsammelbalken mit Schiebeverschluss
viga recogecables con cierre superior corredizo

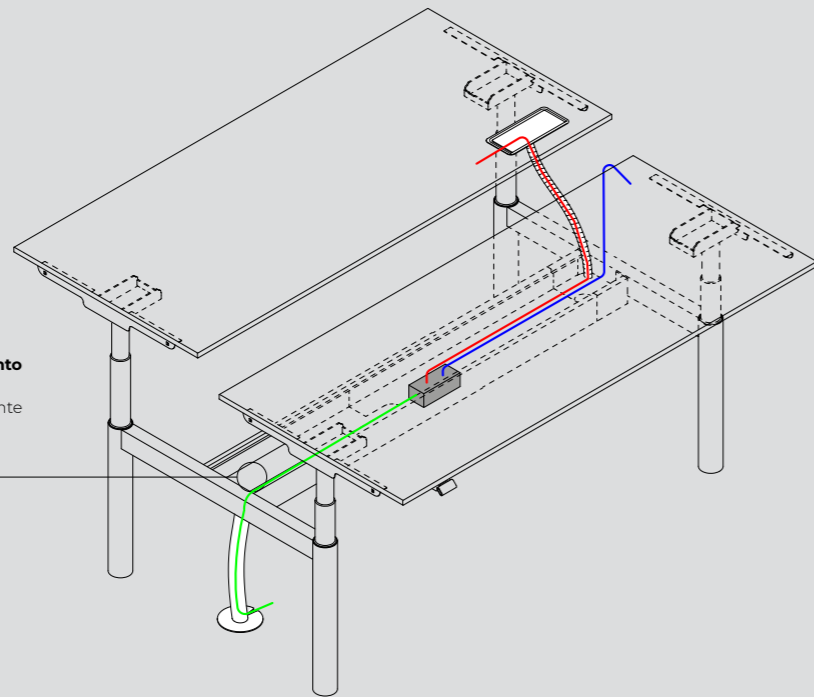



melaminico • melamine • mélamine • melamin • melamina



nero
black
noir
schwarz
negro



grigio titanio
titanium grey
gris titane
titangrau
gris titanio



grigio perla
pearl-grey
gris perle
perlgrau
gris perla



tortora
turtledove
tourterelle
taubengrau
tórtola



bianco
white
blanc
weiß
blanco



noce Lux
walnut Lux
noyer Lux
lux Nussbaum
nogal Lux



noce canaletto
canaletto walnut
noyer canaletto
Canaletto Nussbaum
nogal canaletto



rovere naturale
natural oak
chêne naturel
Natur Eiche
roble natural



rovere anticato
traditional oak
chêne vieilli
Eiche Antik
roble antiguo

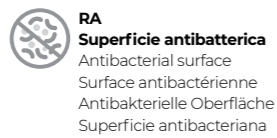

RA Superficie antibatterica
Antibacterial surface
Surface antibactérienne
Antibakterielle Oberfläche
Superficie antibacteriana

metallo • metal • métal • metall • metal



nero
black
noir
schwarz
negro



grigio titanio
titanium grey
gris titane
titangrau
gris titanio

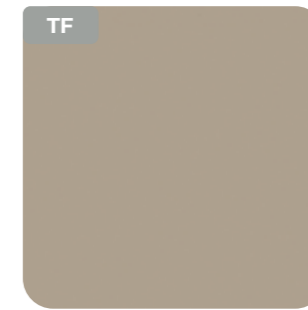

tortora
turtledove
tourterelle
taubengrau
tórtola

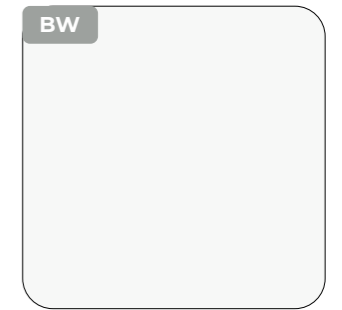

bianco
white
blanc
weiß
blanco

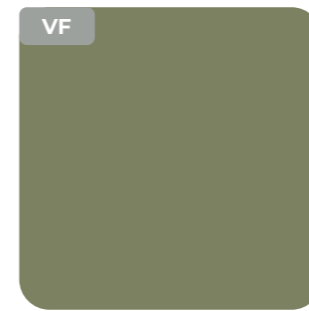

oliva
olive
olive
olive
oliva

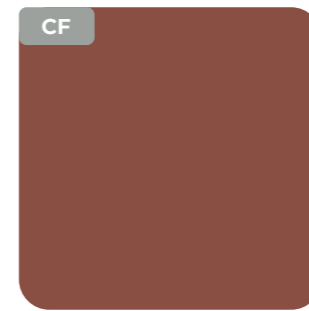

terracotta
terracotta
terre cuite
terrakotta
terracota



grigio ombra
shadow grey
gris ombre
vulcanschwarz
sombra gris



rame rosa
pink copper
cuivre rose
kupfer-Pink
cobre rosa



tessuto • fabric • tissu • stoff • tejido

MIRAGE

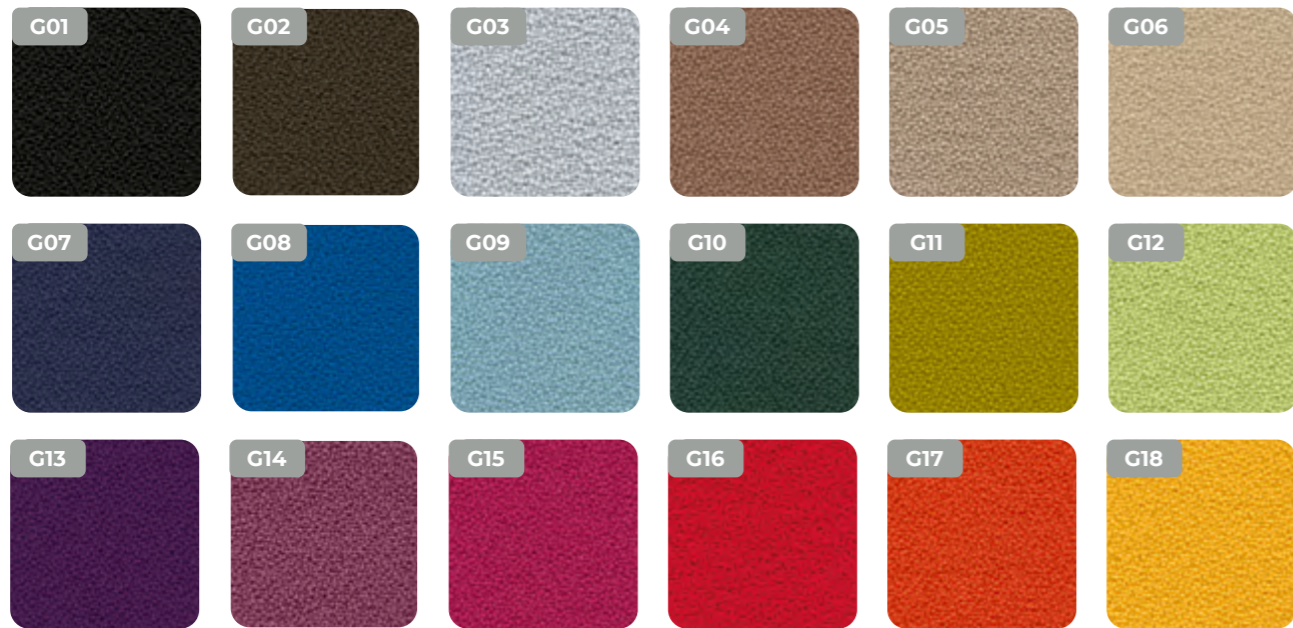

NEMI MELANGE

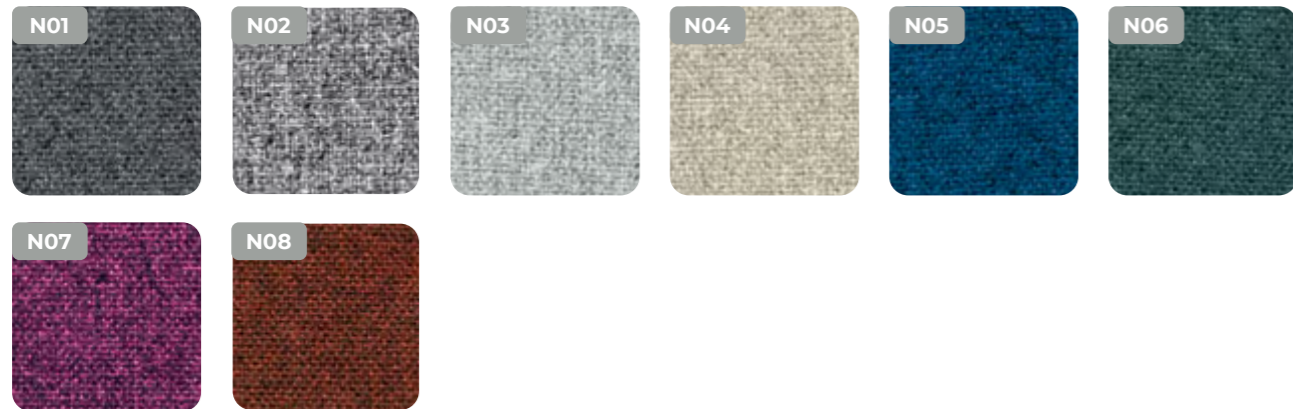

FENICE

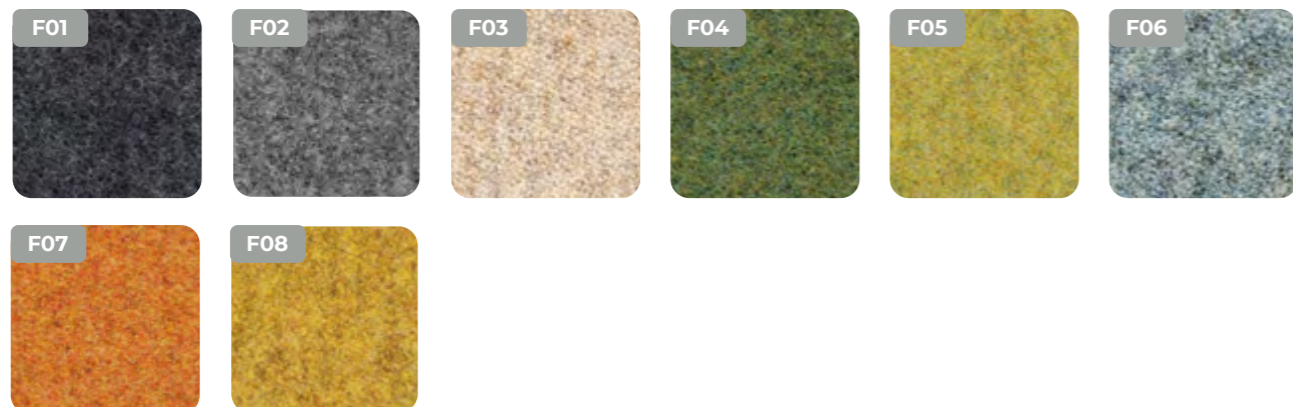

CONVERT MEL 4000

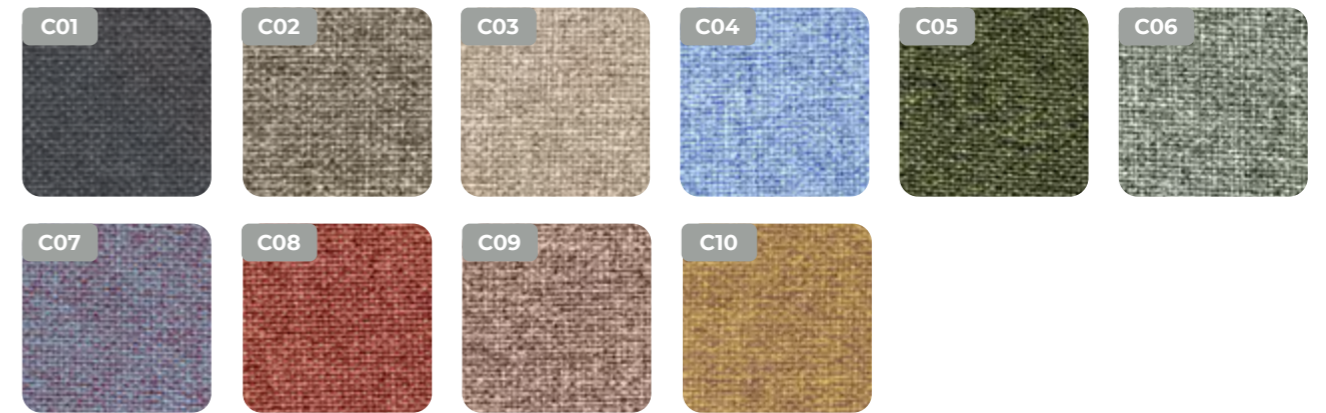

CURA

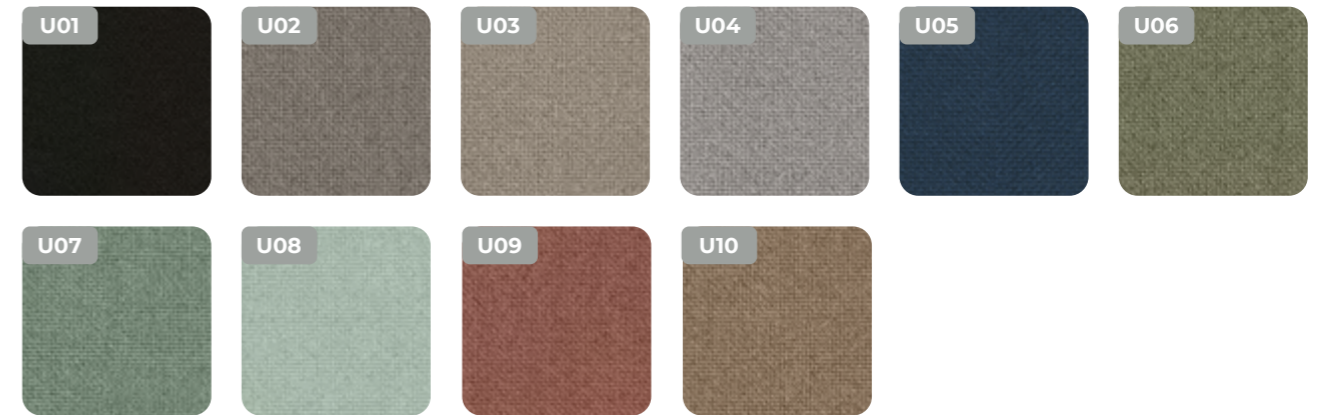

POSEIDON

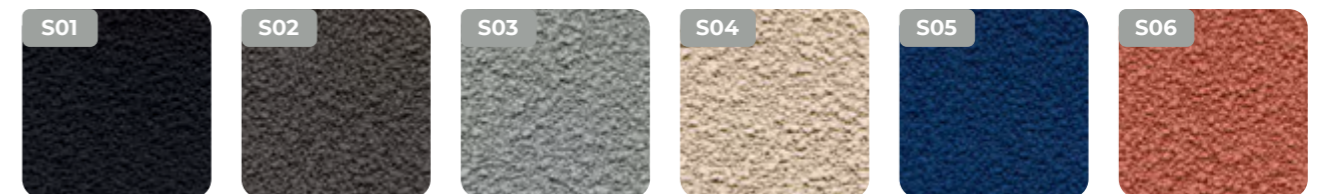



selezione delle materie prime • selection of raw materials • sélection des matières premières • Auswahl der Rohstoffe • seleccion de materias primas

attenzione e cura nella scelta dei materiali: Legno impiallacciato / vetro / pelle / tessuto • attention and care in the selection of materials: veneer / glass / leather / fabric • attention et soin dans la sélection des matériaux: bois plaquage / verre / peau / tissu • Aufmerksamkeit und Sorgfalt bei der Auswahl der Materialien: Holzfurnier / Glas / Leder / Stoff • atención y cuidado en la selección de los materiales: madera pintada / vidrio / piel / tejido



produzione certificata, ecologica e rispettosa dell'ambiente e dell'utente • certified production, green environmentally and user friendly • production certifiée, écologique et respectueuse de l'environnement et de l'individu • Zertifizierte, umweltfreundliche Produktion mit großer Respekt für Umwelt und Nutzer • Produccion certificada, ecologica y respetuosa del ambiente y del usuario



progettazione • space planning • projets • Projekte • proyectos



capacità di produzione industriale • industrial production ability • capacité de production industrielle • industrielle Produktionskapazität • capacidad de producción industrial



garanzia e disponibilità dei componenti • warranty and availability of components • garantie et disponibilité des composants • Garantie und Verfügbarkeit der Komponenten • garantía y disponibilidad de los componentes



esperienza • experience • expérience • Erfahrung • experiencia



articoli speciali • special items • articles spéciaux • Sonderanfertigungen • artículos especiales



imballi costituiti da materiali facilmente separabili e riciclabili • recyclable and easy to dispose packagings • emballages constitués de matériaux facilement séparables et recyclables • Die Verpackungen ermöglichen ein schnelles Trennen und Wiederverwertung von Materialien • embalaje constituido de materiales simplemente separables y reciclables



riduzione di formaldeide e di sostanze tossiche e potenzialmente dannose • low formaldehyde emission, low toxic and potentially harmful substances • réduction de formaldéhyde et des substances toxiques et potentiellement nocives • Reduzierung von Formaldehyd und Giftstoffe, die eine potentielle Gefahr darstellen • reducción de formaldehido y sustancias tóxicas y que pueden ser dañinas



estensione del ciclo di vita dei prodotti • product life extension • extension du cycle de vie du produit • Erweiterung der Produktlebensdauer • extension del ciclo de vida de los productos



produzione di arredi a ridotto impatto ambientale • furniture products with reduced environmental impact • production de mobiliers à impact environnemental réduit • Produktion von Einrichtungen mit niedriger Umweltbelastung • producción de mobiliario con reducido impacto ambiental



facilità di disassemblaggio per favorire la riconfigurabilità, il riutilizzo o il riciclo • easy reconfiguration, reuse or recycling • simplicité de démontage pour favoriser la reconfiguration, la réutilisation ou le recyclage • Leichte Zerlegung um Rekonfigurierbarkeit, Wiederverwendung oder Recycling zu ermöglichen • facilidad de desensamblaje para facilitar el configurar de nuevo, reutilizar y reciclar

il nostro sistema di produzione segue standard avanzati per la cura dell'individuo e della natura • our production system follows advanced standards for individual and nature care • notre système de production suit des standards avancées pour le soin de l'individu et de la nature • Unser Produktionsverfahren fortschrittlichen Standards für den Schutz von Mensch und Natur • nuestro sistema de producción sigue estandard avanzados para el cuidado al individuo y a la naturaleza.

la nostra azienda opera con l'obiettivo primario di garantire prodotti che raggiungano un corretto equilibrio tra sostenibilità ambientale e design • our Company operates with the primary objective of guaranteeing products that achieve a correct balance between, environmental sustainability and design • notre société a comme objectif principal celui de garantir des produits qui atteignent un juste équilibre entre, durabilité environnementale et design • Unsere Firma hat sich als Hauptziel die Garantie von Produkten gesetzt, welche ein korrektes Gleichgewicht zwischen Umweltverträglichkeit und Design erzielen • nuestra empresa trabaja con el objetivo primario de garantizar productos que alcanzan un correcto equilibrio entre sostenibilidad ambiental y de diseño



California 93120
Compliant for Formaldehyde Phase 2



The mark of responsible forestry

I nostri prodotti in melaminico possono essere forniti FSC® su richiesta cliente • Our melamine products can be FSC® supplied upon customer request • Nos produits en mélaminé peuvent être fournis certifiés FSC® sur demande du client • Unsere Melamin-Produkte können auf Anfrage des Kunden in FSC® geliefert werden • Nuestros productos de melamina pueden ser suministrados FSC® a petición del cliente

Bralco Srl
Via Luigi Einaudi, 1
31058 Susegana (TV) Italy

T +39 0438 43 77
info@bralco.it
bralco.it

follow us on:



project: gherardi architetti
images: gherardi architetti, virtual design
printed: grafiche antiga
06_2024

Thanks to:
Anastasiades, Fornace Brioni, Mutina

Particolari tecnici ed estetici possono essere modificati senza preavviso.
Le rese cromatiche non sono vincolanti così come la fedeltà della riproduzione.
Dati, misure e dettagli devono essere verificati con il listino.

Technical and aesthetic details can be modified without notice.
Colour rendering may differ.
Check the data, measures and details on the price list.

Les détails techniques et esthétiques peuvent être modifiés sans préavis.
Le rendu chromatique n'est pas contractuel, ainsi que la fidélité de la reproduction.
Les données, les mesures et les détails doivent être vérifiés avec le tarif.

Technische und ästhetische Details könnten ohne Voranmeldung geändert werden.
Die Echtheit der Farbwiedergabe ist nicht verbindlich.
Daten, Maße und Details sind in der Preisliste zu überprüfen.

Los detalles técnicos y estéticos pueden ser modificados sin preaviso.
Los rendimientos de color y la fidelidad de la reproducción no son vinculantes.
Los datos, las medidas y los detalles deben ser verificados con la tarifa de precios.



